



UNSW
AUSTRALIA

Canberra

Never Stand Still

School of Humanities and Social Sciences

The Ottoman Artillery at Anzac



Schweres Geschütz.

Mesut Uyar, Ph.D. PD
Associate Professor



The Elite of the Army



Field Artillery



Foot (Fortress) Artillery

Artillery Branches

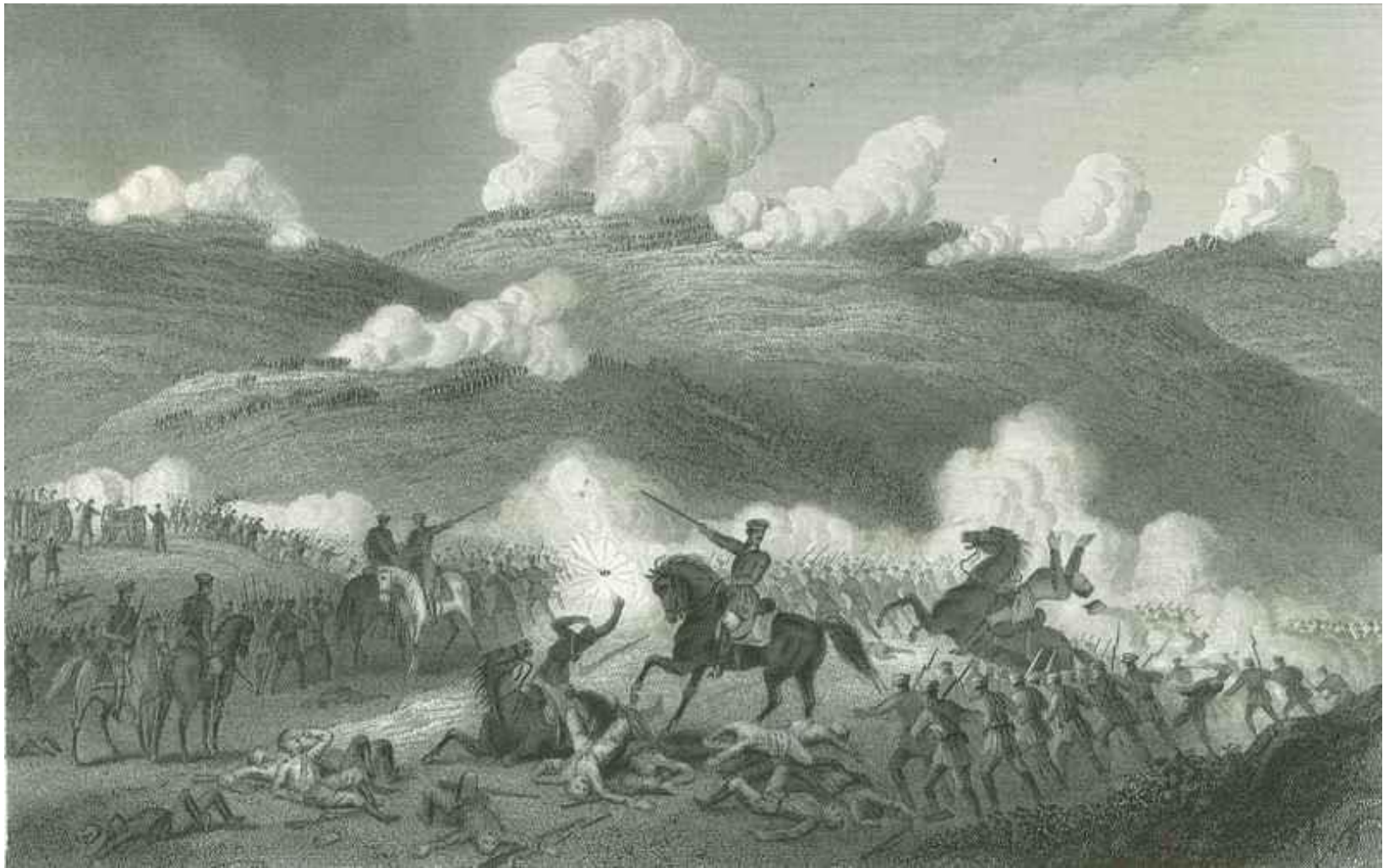

Always the Best at War

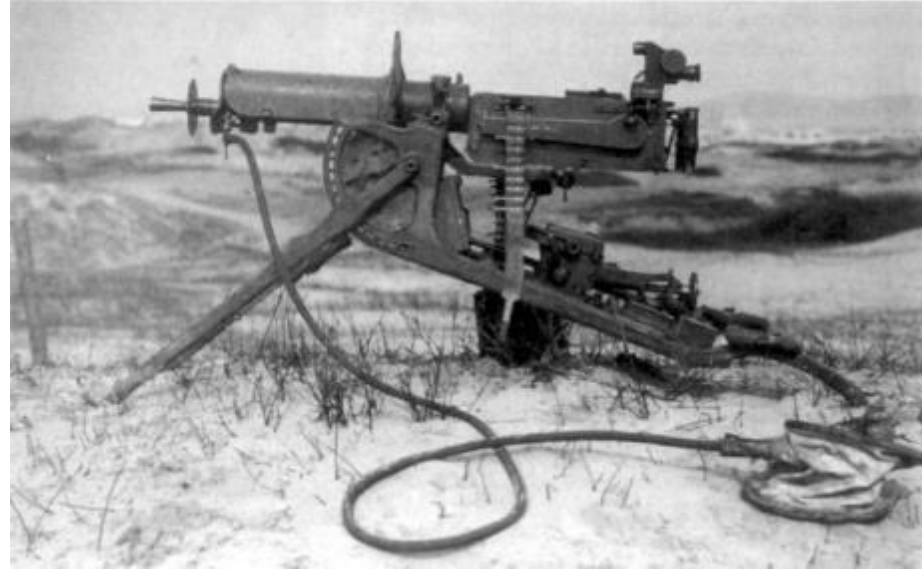

Deadly Combination

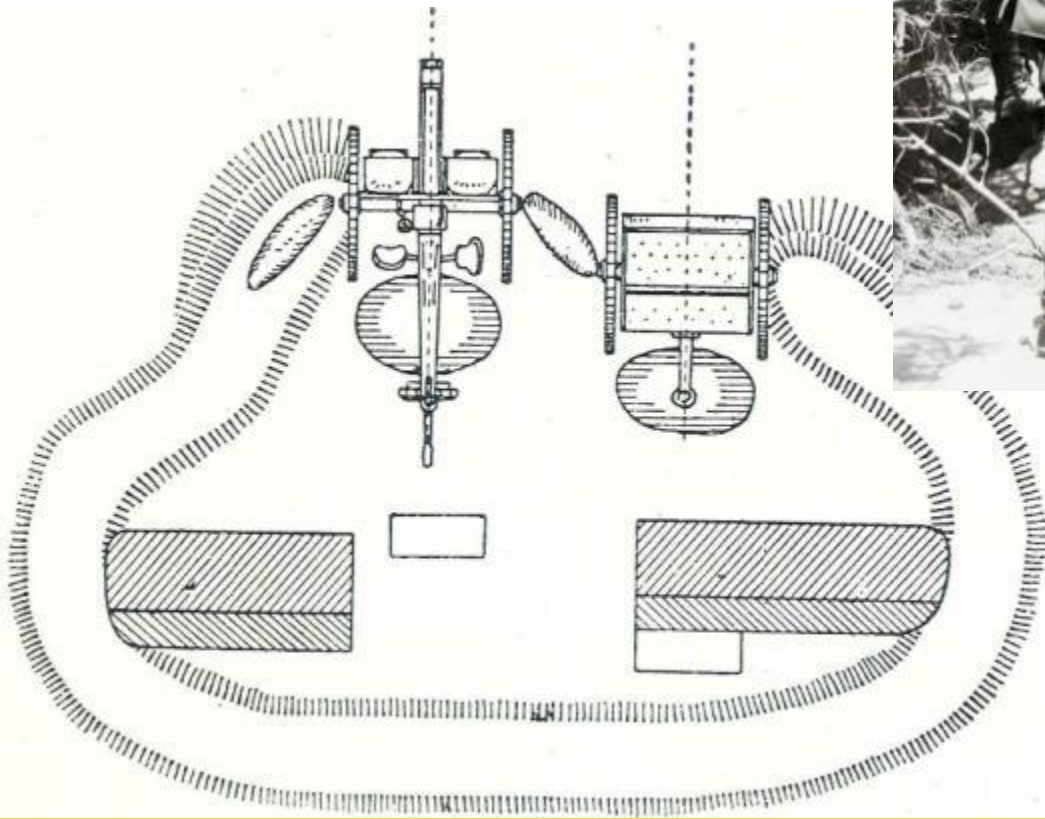

Dig! Dig! Dig!

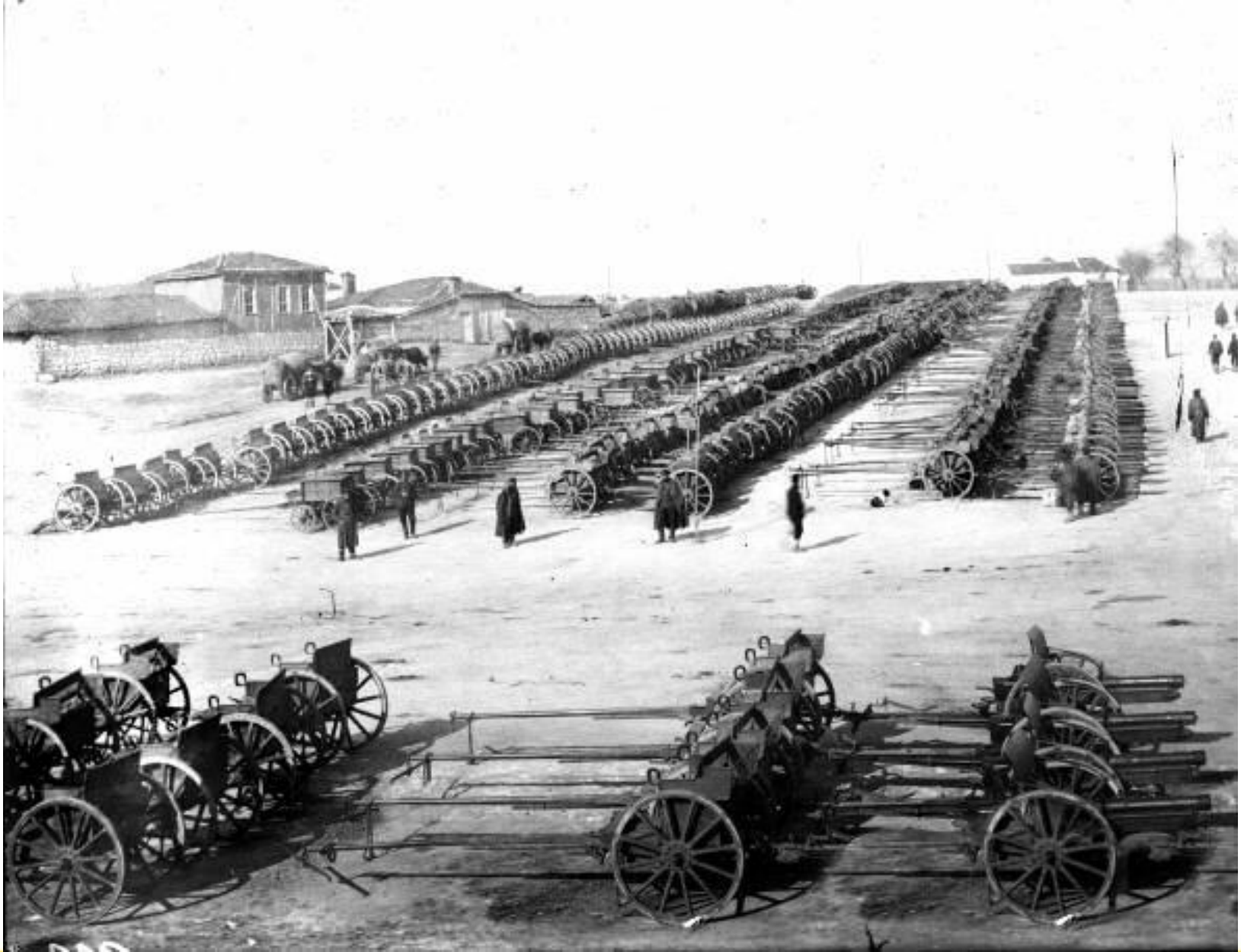

**Ottoman Guns Captured by
Bulgarians**

Square Division

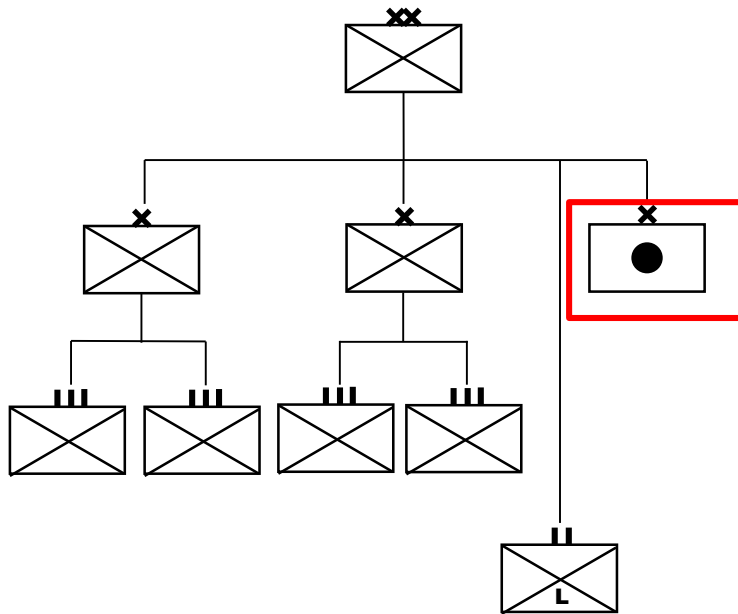

16 line infantry battalions (3 coys each)

1 light infantry battalion

4 artillery battalions

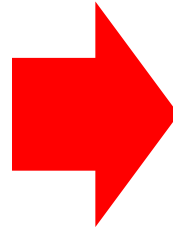

Triangular Division

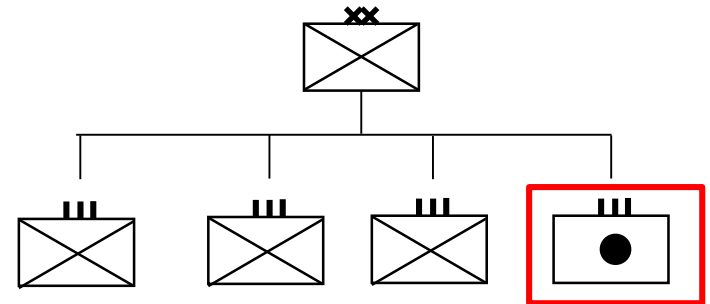

12 line infantry battalions (4 coys each)

3 artillery battalions

1911 Transition to Triangular Division System

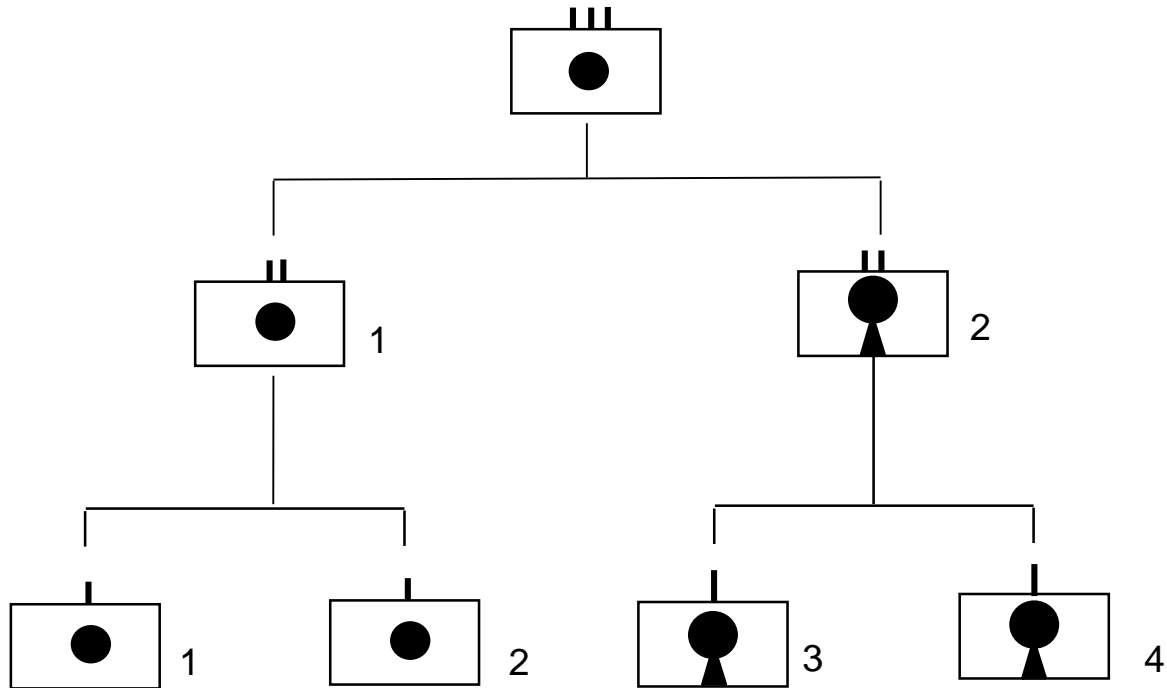

8 x 75mm Krupp Feldkanone L/30 M1903

8 x 75mm Krupp Gebirgskanone L/14 M1904

Divisional Field Artillery Regiment (16 guns)



**75mm Krupp Feldkanone L/30
M1903**



**75mm Krupp Gebirgskanone L/14
M1904**



87mm Krupp Feldkanone L/24 M1885



Old 75mm Krupp Gebirgskanone

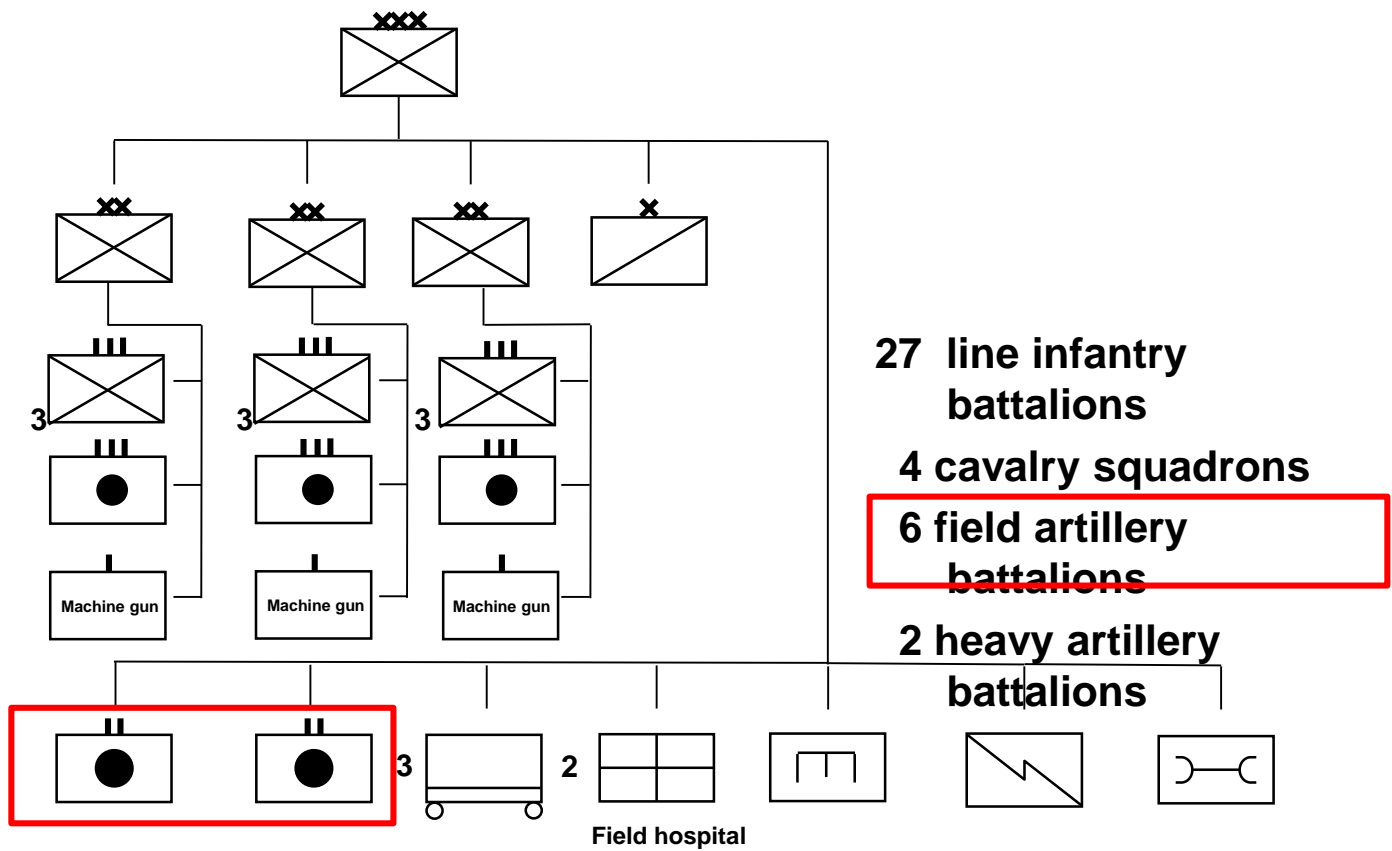

- 27 line infantry battalions
- 4 cavalry squadrons
- 6 field artillery battalions
- 2 heavy artillery battalions

Triangular Army Corps with Two Heavy Artillery Battalions



STRETTO DE DARDANELLI

1. Fortezza di SESTO in Europa. 2. Borghi.

3. Fortezza di ABIDO in Asia. 4. Borghi.

Disegnato da Gio. Giacomo de Balthalle. Incisa in Roma, alla Pace, per Privilegio del S. Pont. 1744.

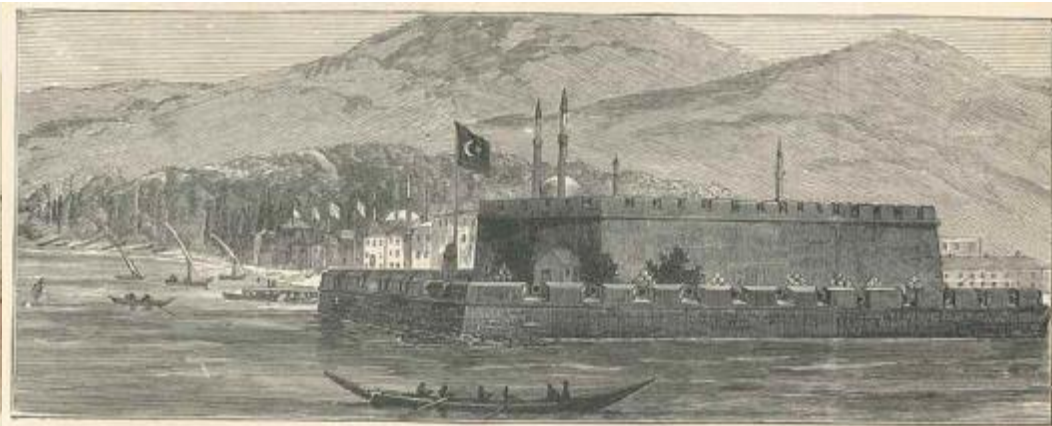
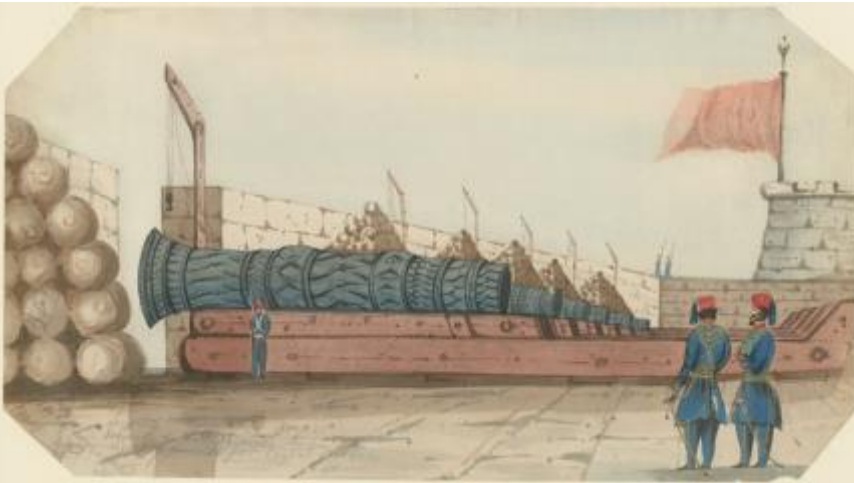

TU'ANAK KALESI, ON THE ASIATIC SHORE,
KEY OF THE DARDANELLES.

The Dardanelles Strait had been a fortress command for many centuries

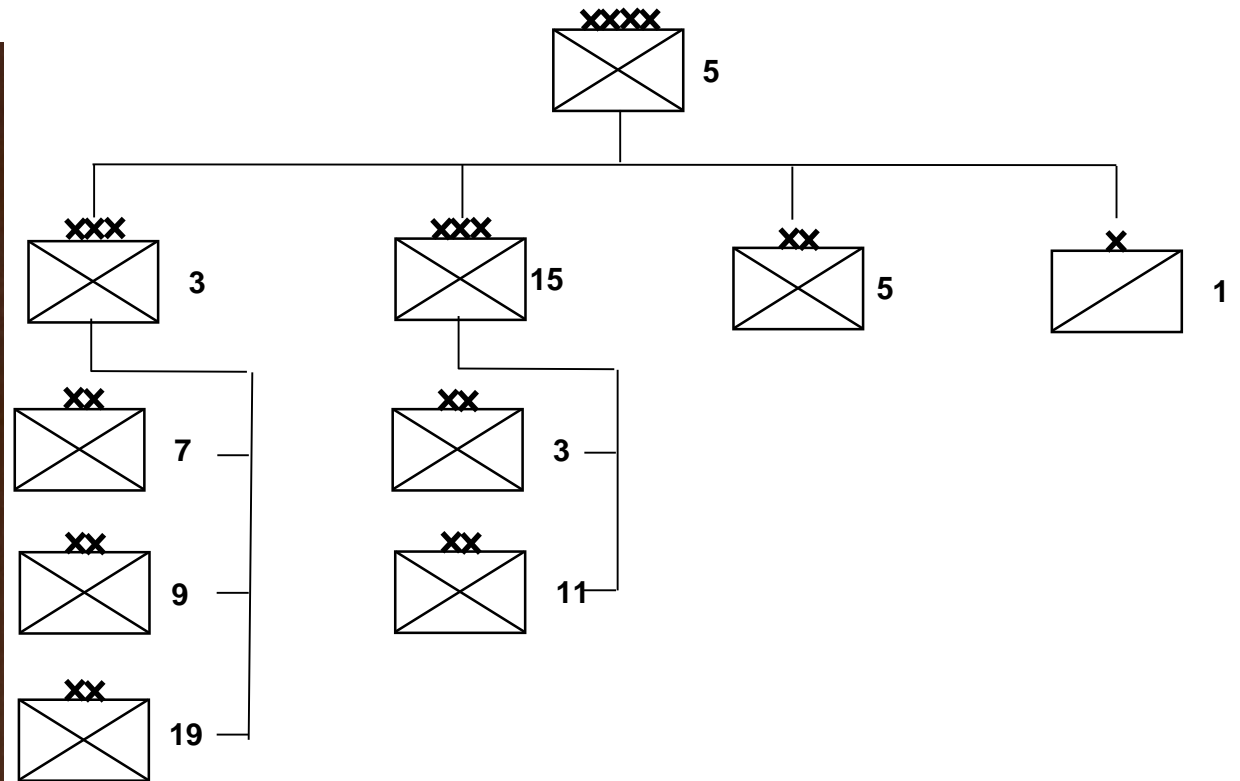

Liman von Sanders and Fifth Army April 1915

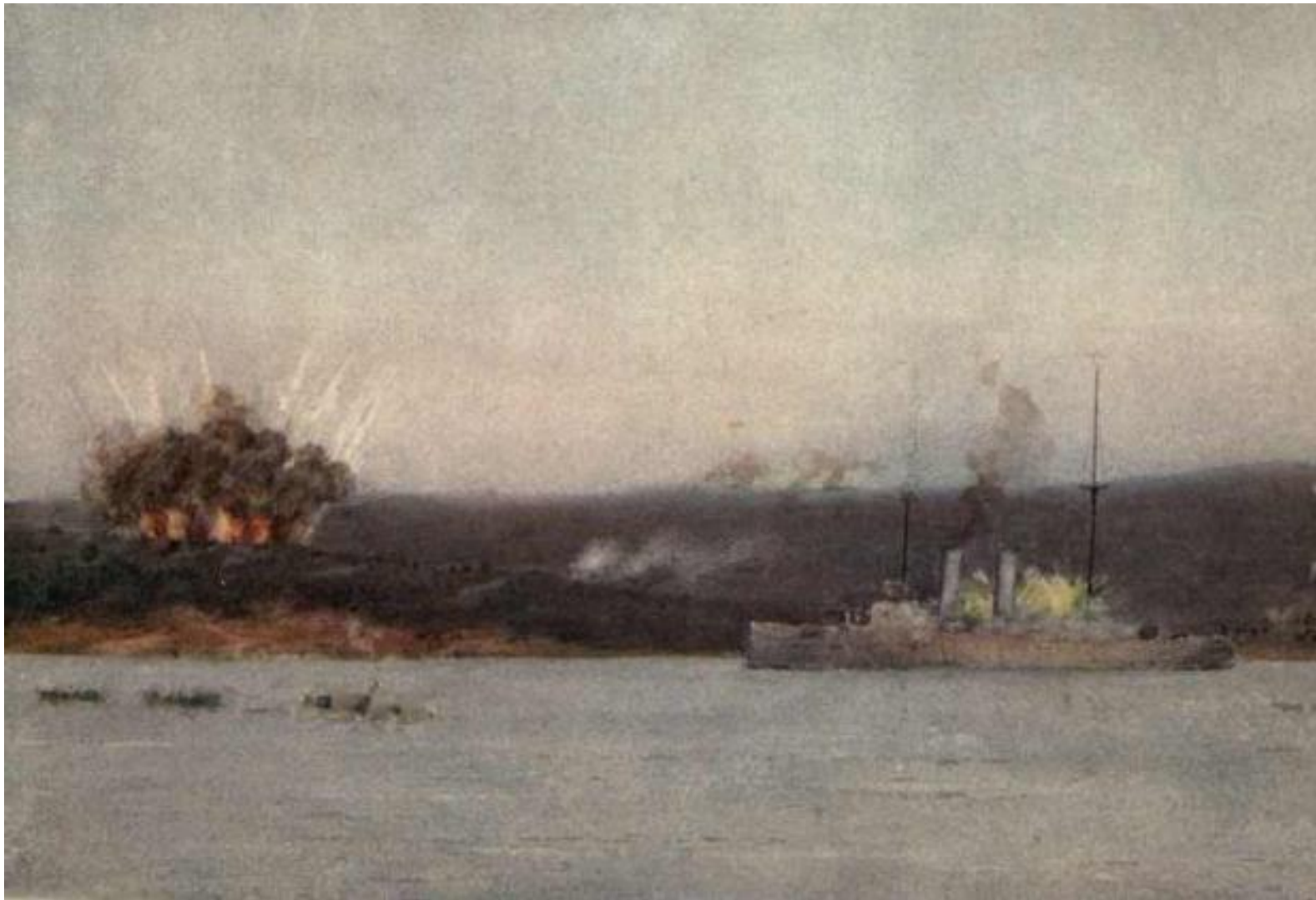

**Naval Gunfire Impressive Sight but
Useless against Entrenched Units**



Trench Warfare



Esad Pasha

**Ottoman Defence at
Anzac**

6 August 1915

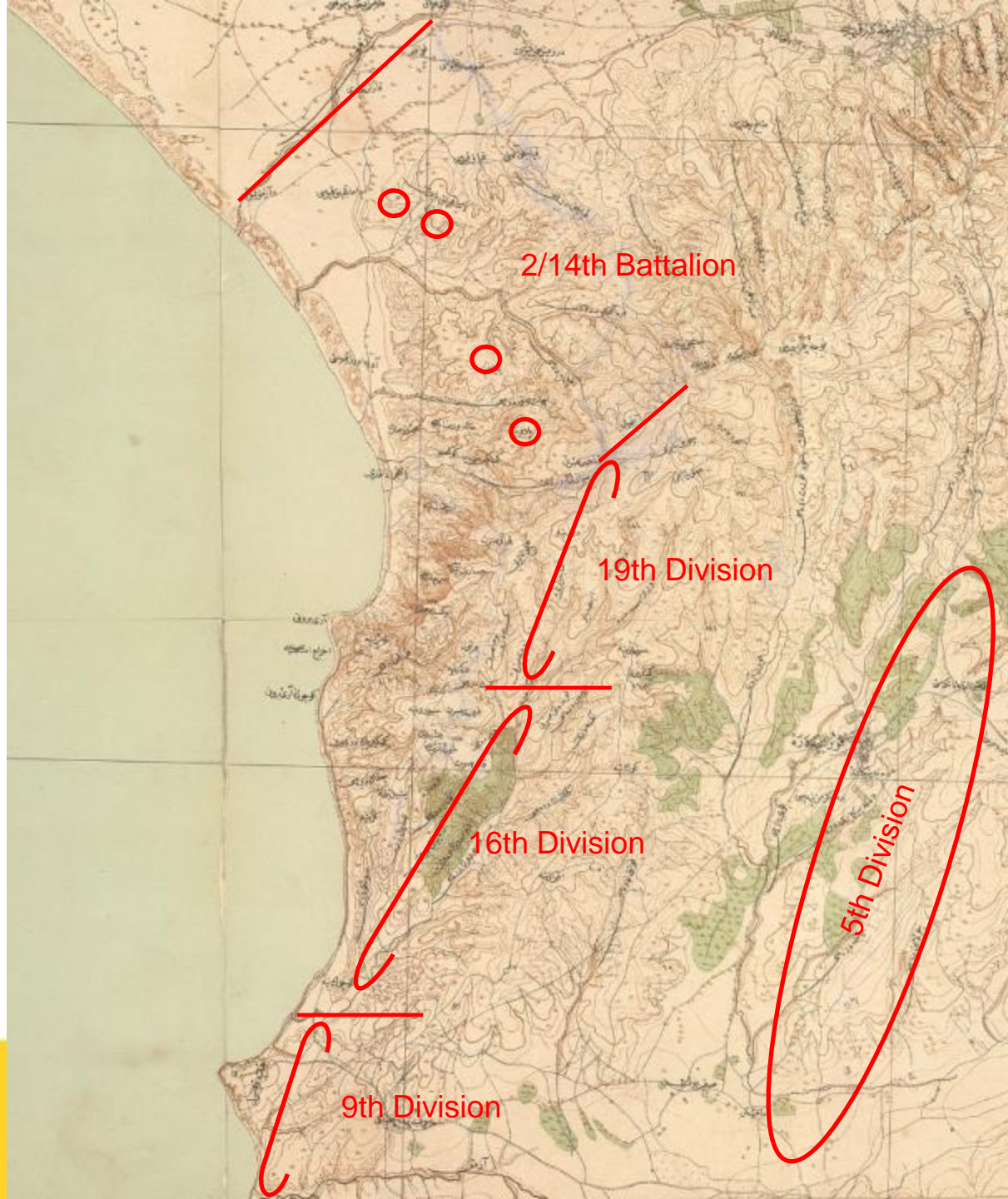

Ottoman Defence at Suvla

6 August 1915



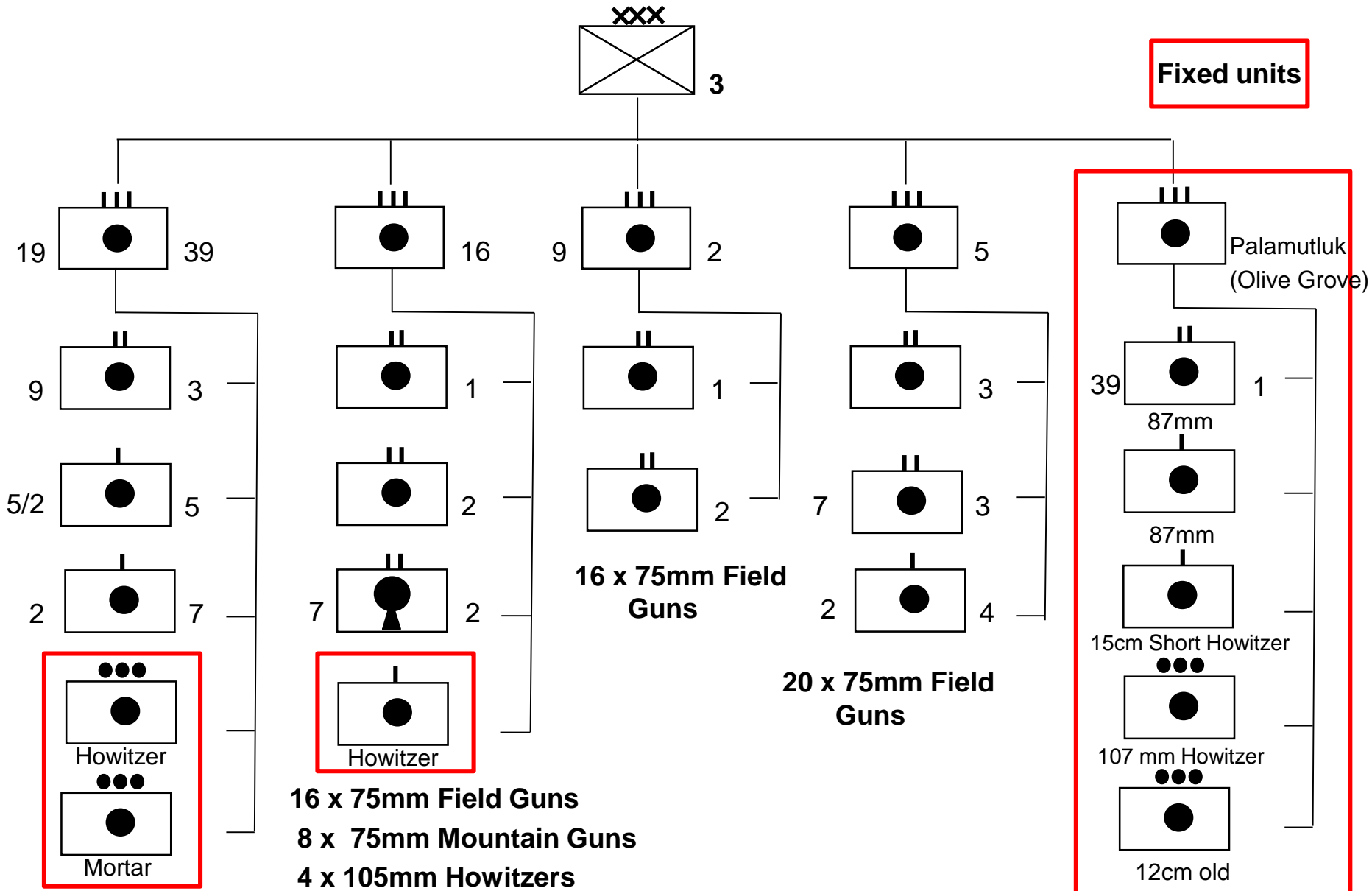

16 x 75mm Field Guns
2 x 50cm Mortars
2 x 15 cm Howitzers

III Corps Artillery Units

12 x 87mm Old Field Guns
4 x 15cm Short Howitzers



Shell 5900m
Shrapnel 5400m

68 x 75mm Krupp Feldkanone L/30 M1903



4800m

**8 X 75mm Krupp Gebirgskanone L/14
M1904**

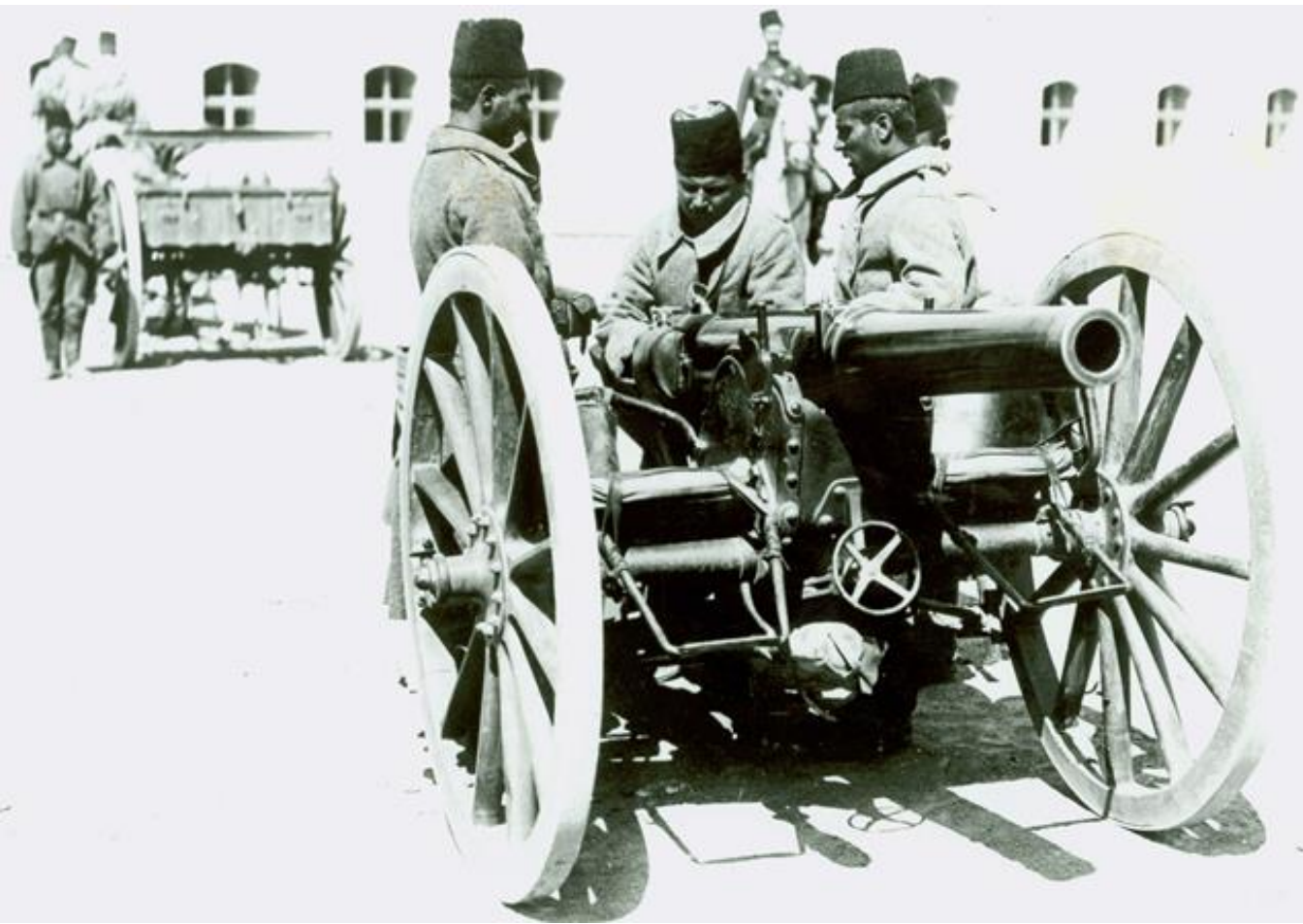

Shell 6800m
Shrapnel 5200m

12 x 87mm Krupp Feldkanone L/24 M1885



5900 m

**4 x 15cm Krupp schwere feld Haubitze
1913**

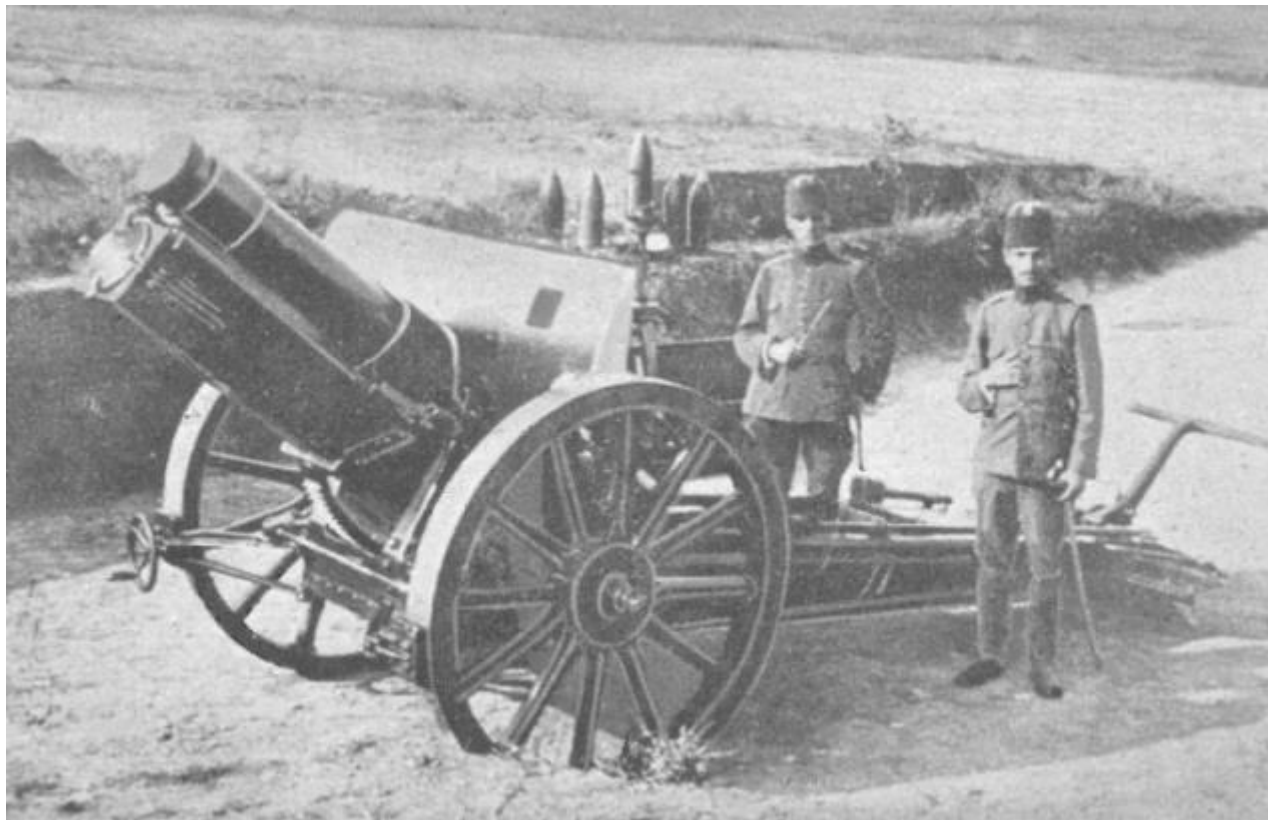

7450 m

**2 x 15cm Krupp lang schwere feldhaubitze
s.F.H. 1913**

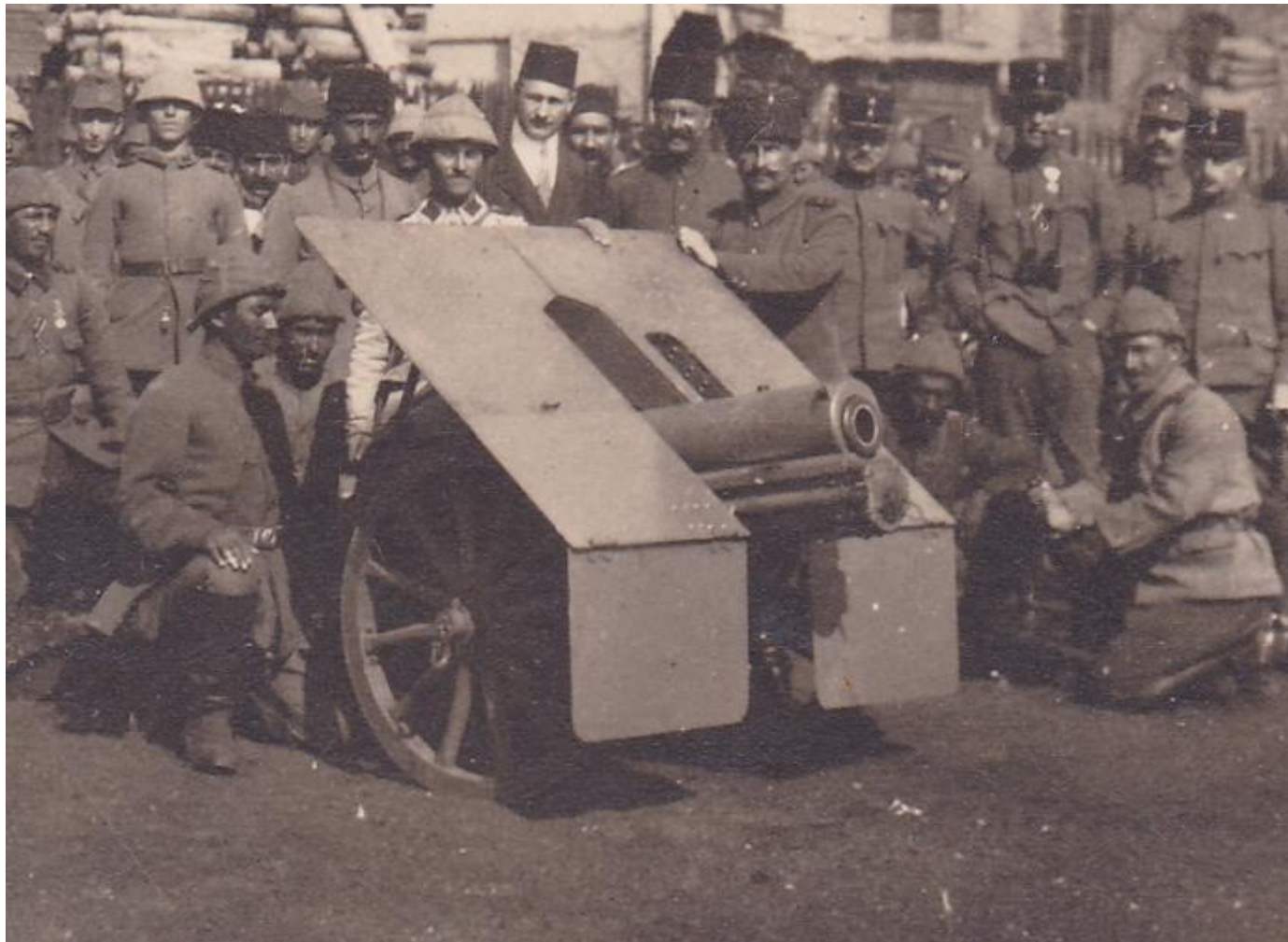

4 x 105mm Krupp field Haubitze 1913

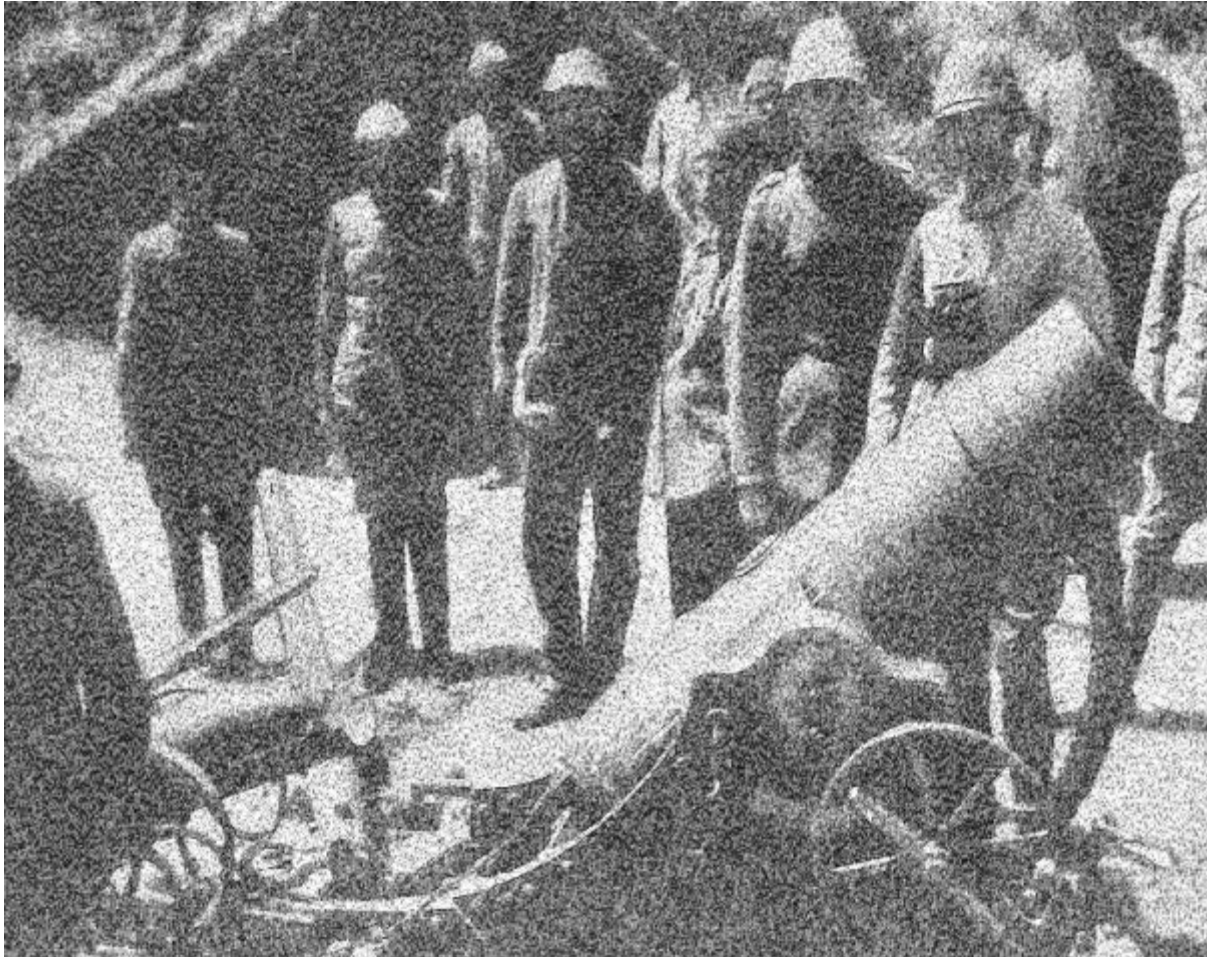

2 X 50cm Old Krupp Mortar



Assortment of Old and Ancient Mortars

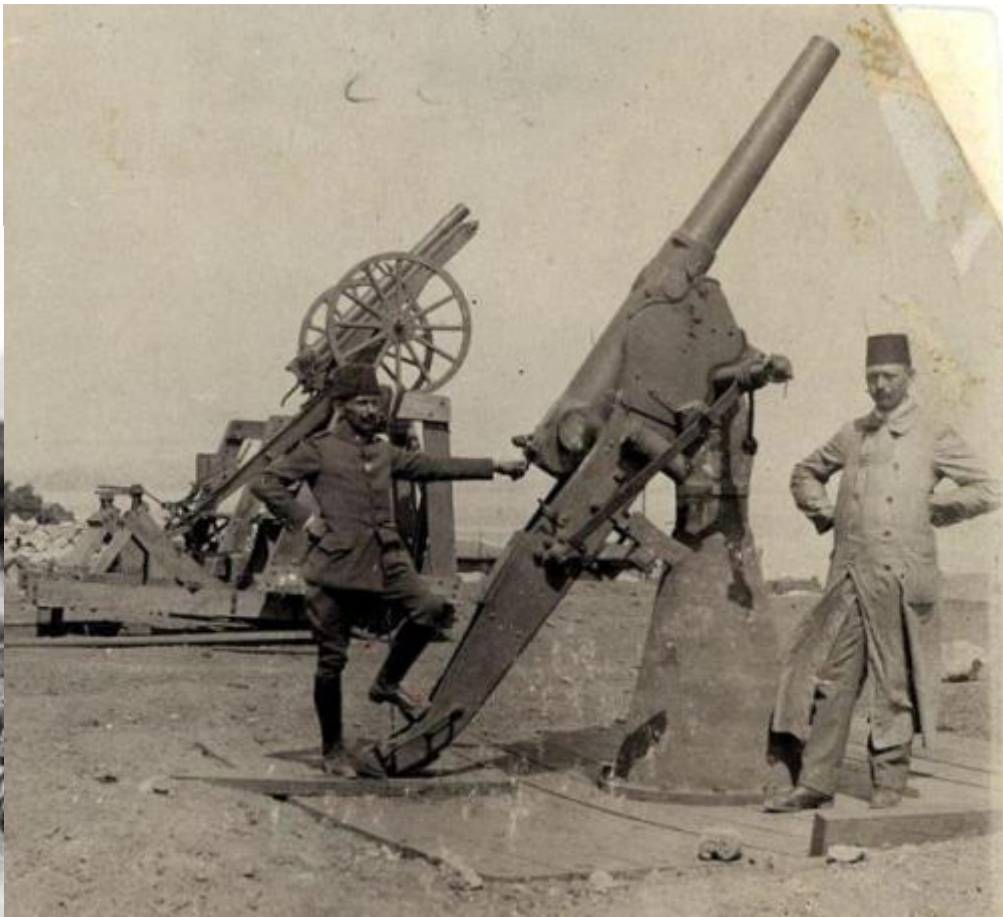

Field Artillery Modified for Anti-air role

- 68 x 75mm Fieled Gun**
- 8 X 75mm Mountain Gun**
- 12 x 87mm Old Krupp Field Gun**
- 4 x 15cm Krupp Short Howitzer**
- 2 x 15cm Krupp Long Howitzer**
- 4 x 105mm Krupp Howitzer**
- 2 X 50cm Old Krupp Mortar**
- 2 X 107mm Krupp Howitzer**
- 2 X 12cm Old Krupp Field Gun**

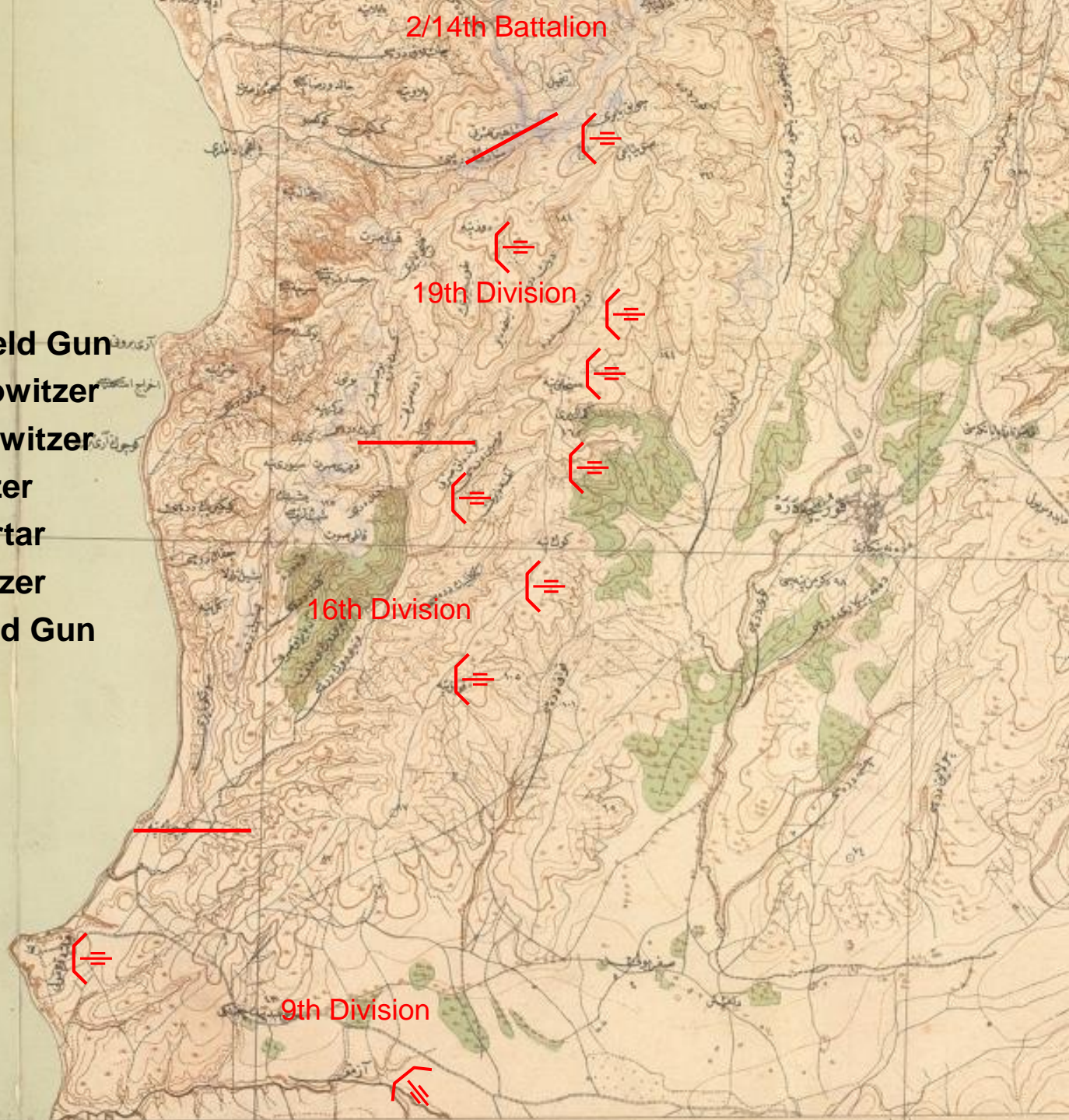

Ottoman Artillery at Anzac



Well-Fortified and Concealed Positions

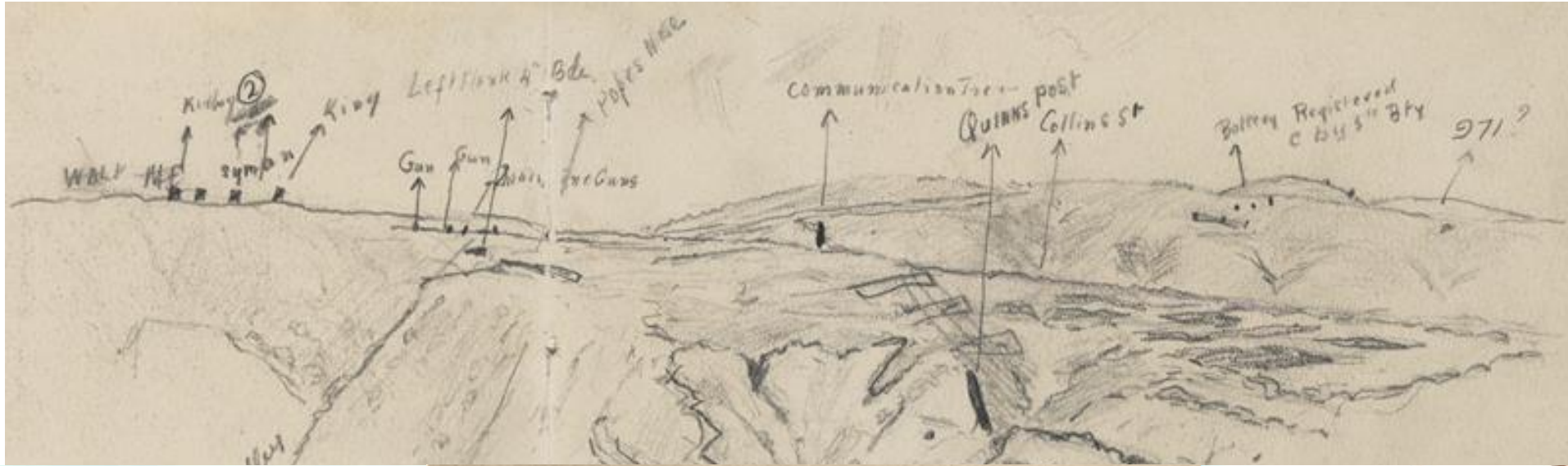

Where were the Ottoman Guns?



More and Bigger Artillery



Tanks



Trench Weapons



Gas

Breaking the Deadlock: Technical Means



QUESTIONS ?

OPERATION ORDER No. 9

by
Brigadier-General H.B. WALKER, D.S.O.,
Commanding 1st Australian Division.

A	4/1/43
D	3
F	1-6

Divisional Headquarters,
24th August, 1943.

Reference : Map of SAHAPOLI PENINSULA 1/80,000 4. 2. 1941
French Diagram No. 11.

Information. 1. -- As a prelude to major operations elsewhere, the outline of which has been communicated confidentially to brigade commanders, the 1st Australian Division is to take action on its present front with the object of preventing the enemy moving reserves to other areas.

Intention. 2. -- The 1st Australian Division and attached troops will :-
(i) hold the present entrenched line from
HEATHMAN'S to GOURNEMAN'S POST (inclusive);
(ii) attack and capture the works known as :-
(a) LONG FINE, and
(b) GERMAN OFFICERS' TRENCH.

Distribution. 3.
A ARRANGEMENTS FOR HOLDING EXISTING LINE.

(i) To hold the line referred to, troops will be disposed as follows :-
2nd Inf.Bde. -- On its present front, including advanced posts.
3rd Inf.Bde. -- The posts and line now held by this brigade up to and inclusive of D.S. TURNER POST.
2nd Inf.Bde. -- From D.S. TURNER POST exclusive up to and including GOURNEMAN'S POST.
D.S. TURNER and the crater near D.S. will be held by the 2nd Inf. Bde. after the troops of the 1st Inf. Bde. have moved to the attack, to protect the northern flank.

Troops will be distributed on this line holding such points d'appui as offer special advantages :-

- (a) to support the 1st Infantry Brigade;
- (b) to thin the firing line elsewhere.

These points d'appui will be prepared at once under the directions of the C.S. Divisional Engineers.

Brigade commanders will submit tables showing the distribution of troops in detail to these points.

The new positions will be taken up by the evening of the 5th August.

**Captured Operational
Order of the 1st**

A	4/879
D	36
P	2



OPERATIONAL ORDER NO. 2

BY
Lieut Colonel Charles Rosenthal, F.A.,
C.O. Artillery, No. 1 Section.

REFERENCE:-
AHEAD QRS,
2. 2024.A.

3rd F.A. Brigade Head Quarters,

Amso. 8th August 1918.
6 8 1311

(1) INFORMATION. Herewith enclosed "A" is a copy of General Artillery instructions issued by G.O.C. Divisional Artillery. Information has been given confidentially to Battery Commanders as to projected operations and assistance of Artillery in No. 2 Section.

(2) ARTILLERY COOPERATION. At 1730 on 8th August the preliminary disposition of Artillery in No. 1 Section will be as follows:-

- (A) 2nd BATTERY. No. 1. Sec. GARA HIPS WITH TRENCHES and Country Southward to OLIVE GROVE.
- 3rd BATTERY. Trenches on FINE RIDGE to COURAGE 400.
- 4th BATTERY. BOWLING GREENS, POPPY VALLEY and Southern end of FINE RIDGE Trenches.
- 5th BATTERY. SWIFTS RIDGE and north of COURAGE 400.

- (B) 6th BATTERY. RIGHT SECTION. OLIVE GROVE GUNS.
LEFT SECTION. VIEW GLASS GUNS.

- (C) HEAVY BATTERY. No. 1. 6" Howitzer. on "ACORN" 6" Howitzer.
No. 2. 6" Howitzer. on VIEW GLASS GUNS.
4"7... on "HEADQUARTERS" GUNS.

- (D) 4th Light Brigade.
1. Section. on OLIVE GROVE GUNS.
1. Section. on VIEW GLASS GUNS.

Other objectives may be allotted to Batteries as the situation develops.

(E) OBSERVATION. Battery Commanders are to ensure careful observation of the zones allotted to them and be prepared to surge immediately any fleeting opportunities.

Captured Operational Order of the 1st Australian Divisional Artillery

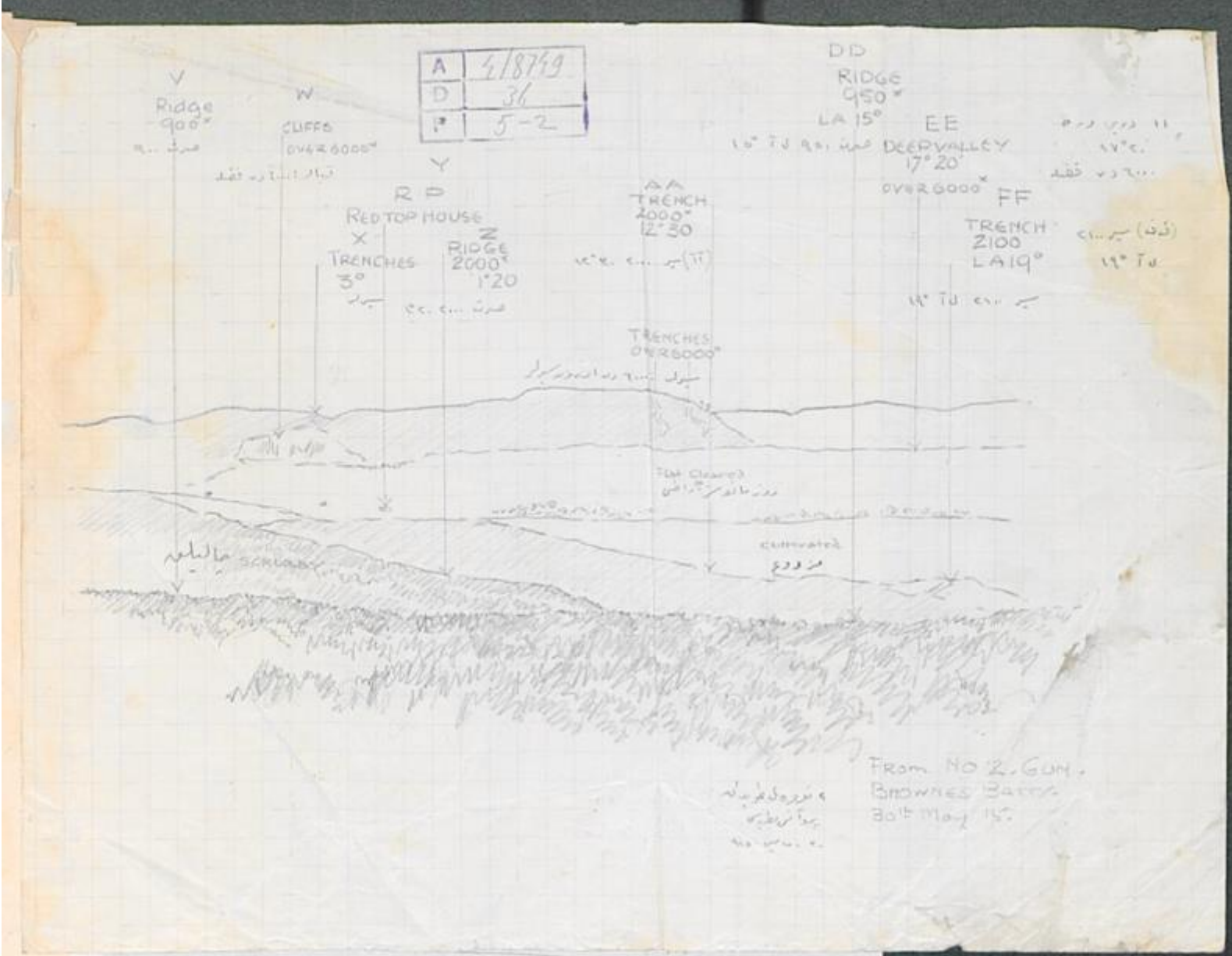

Captured Sketches



24cm Motor-Mörser-Batterie Nr.9



15cm Haubitzbatterie Nr.36

Austro-Hungarian Heavy Artillery Batteries



COURTESY PETER ROBB, MURAT DEMIR, ZIVAARTAM

North of Anzac